



**RIVALE PROFILE** is the first ultra-equipped luminaire in AYRTON's brand new "ULTIMATE" series, all models being perfectly re-scaled and sharing common features, delivering previously unimaginable weight to output ratios.

Introducing the RIVALE PROFILE, the flagship luminaire in AYRTON's groundbreaking "ULTIMATE" series, where every model shares a re-scaled design and common features, revolutionizing weight-to-output ratios. Crafted for versatile applications both indoors and outdoors, RIVALE PROFILE stands unrivalled in the market with its distinctive visual signature. Weighing a mere 30.8 kg, it redefines performance standards, boasting capabilities unprecedented in its category.

## ★ KEY FEATURES

### ➤ Revolutionary Design

AYRTON's RIVALE PROFILE is the flagship luminaire in the "ULTIMATE" series, introducing a re-scaled design and common features that redefine weight-to-output ratios.

### ➤ Versatility Redefined

Crafted for both indoor and outdoor use, the RIVALE PROFILE weighs only 30.8 kg, delivering unparalleled performance in its category.

### ➤ Innovative Lighting Control

Featuring continuous pan and tilt movement rotation, this luminaire provides enhanced creativity and freedom in lighting design.

### ➤ High Definition Optics

13-to-1 zoom ratio and a zoom range spanning from 4 to 52°. With a 160 mm frontal lens, the RIVALE PROFILE produces an ultra-intensive 4° beam, reminiscent of AYRTON's renowned "LT" versions.

### ➤ Cutting-edge Technology

Equipped with a high-efficiency 430-watt sealed monoblock LED module calibrated at 6500 K and Peak engine, RIVALE PROFILE offers a luminous flux of 30,000 lumens for optimal light neutrality.

### ➤ Colour Precision

The luminaire introduces a high-definition progressive CMY colour-mixing system with an overhaul, extended progressive CTO, progressive CRI wheel and a seven-position colour wheel, allowing precise colour temperature adjustment from 2700 K to 6500 K and a truly diverse colour palette.

### ➤ Multi-functional Effects

RIVALE PROFILE includes a framing section for accurate shutter blade positioning, a 15-blade iris diaphragm for beam optimization, and an image section with 15 interchangeable high-definition glass gobos, as well as a monochromatic animation wheel, rotating prisms, and frost filters, making it AYRTON's most versatile fixture to date.

## TECHNICAL SPECIFICATIONS

SOURCE	
Engine	LED Mono Block Sealed White
LED Watts	430 W (total fixture use, see Electrical section)
LED Engine Life (L70)	Up to 40,000 hours
LED Refresh Rate	1.2 kHz, 2.4 kHz, 16 kHz, 25 kHz
Dimming	Electronic
Dimming Curves	Square & Linear
Dimming Control Options	Auto on/off dimmer smoothing when Snap effects
Strobe Speed	Hz 1-25 Per Second
Strobe Modes	Strobe Effects / Pulse Effects / Random Effects

ELECTRICAL	
Max Power Consumption	700 W
Standby Consumption	100 W @ 20 °C
Voltage Range	100-240 V 50-60 Hz
Current (Max)	3A @ 230 V / 6,3A @ 110 V
Inrush (Half Cycle)	110 V: 14.2 A 230 V: 12.6 A
Total Fixtures per Circuit	5 @ 220/230 V / 3 @ 110 V
Connector	True1 In/Thru
Power Supply Unit	Active PFC
Contains Battery	N/A

TYPICAL POWER AND CURRENT	
120V , 60Hz	5.142 A, 612 W, PF 0.998
208V, 60Hz	2.922 A, 598 W, PF 0.985
230V, 50Hz	2.624 A, 593 W, PF 0.983
240V, 50Hz	2.514 A, 591.5 W, PF 0.981

OPTICAL PERFORMANCE	
Lens Size	160 mm (6.3 in)
Zoom Range	4° to 52°
Zoom Ratio	13:1
Gate Size	22 mm

MOVEMENT		
Pan Range	Infinite	
Pan Speed (End to End or range)	180°	100.7 rpm
	360°	161.6 rpm
	EtoE	207.2 rpm
Tilt Range	Infinite	
Tilt Speed (End to End or range)	180°	88.6 rpm
	EtoE	117 rpm
Resolution	8- or 16-bit	
Calibration Time	66 sec	
Position Correction System	Yes / Automatic repositioning	
Follow Spot Modes	Manual & Tracking system	

COLOUR SYSTEM	
Colour System(s)	CMY, CTO and 7 Colour Wheel
Control	CMY 16-bit & 8-bit
CTO	2700 to 6500 K
Variable CTP	TrueColour Enhancer™ filter to 88 CRI
Colour Wheel	One Wheel. Seven Dichroic changeable colours
Colour Wheel Effects	Continuous Rotation

GOBOS	
Indexing Wheel	1
Indexing Gobos	7 (Glass see load below) + 1 Open
Gobo Diameter (Index)	25.5 mm
Image Diameter (Index)	20 mm
Static Wheel	1
Static Gobos	9
Gobo Diameter (Fix)	25.5 mm
Image Diameter (Fix)	19 mm
Gobo Thickness	1.1 mm
Animation Wheel	Yes
Animation Details	Bi-Directional with continuous rotation

## TECHNICAL SPECIFICATIONS

PERFORMANCE		
LED engine output (Sphere)	35,000	
Fixture Output (Sphere)	28,700 lm (Fan Mode Auto)	
	29,260 lm (Fan Mode Stage)	
	17,200 lm (Fan Mode Silence)	
	12,000 lm (Fan Mode Super Silence)	
Fixture Output (Goniometer)	28,700 (Fan Mode Auto after derating)	
Field Lumens (Goniometer)	Narrow	8,273 lm
	Middle	22,779 lm
	Wide	22,736 lm
Lumen Per Watt (LPW) Max fixture output / 230 V Typical power	35.29	
CCT	6500	
$\Delta uv$	0.0029	
CRI	Ra: 70 ( $\pm 2$ )	
With TrueColour™ Filter	> 70 to 86	
Tm30	Rf: 69 Rg: 93	
TLCI	43	
CQS	66.7	

IMAGING	
Framing	4 Blade – 4 Plain Full Swipe
Framing Rotation	+/- 90°
Iris	15 Leaf - 5% to 100% (Open)
Frost	2 Frost filters: Light 1° & Heavy 5°
Effects	<ul style="list-style-type: none"> <li>Focusable CMY &amp; RGB graphic animation effect-wheel with continuous rotation in both directions</li> <li>2xPrisms: One 5-facet circular &amp; One 4-facet linear indexable, rotating and combinable</li> </ul>

CONNECTORS	
Power	In/Thru powerCON True 1
DMX	In/Thru 5 Pin XLR
Network	In/Thru RJ45
Wireless	DMX Only

CONTROL	
DMX Control	DMX (USITT DMX-512-A) RDM (ANSI/ESTA E1.20)
Transceiver/Receiver	RS-485 with Opto Isolation
DMX Modes	3 + 3 User Modes
Channel Count	Mode 1 Extended – 65
DMX Chart	Scan the QR code on page 5
Network Protocols	ArtNet & sACN
Local Control	Colour LCD Panel 5 Menu Buttons NFC
Stand Alone Mode	Master/Slave, presets 250
RDM Functions	Yes
Wireless DMX	CRMX TiMo RDM receiver
E-Sim Ready	Optional
USB Port	No

THERMAL	
Max Surface Temperature, steady state, at Ta 40°	90 °C (194 °F)
Max Ambient Temperature (Ta Max)	45 °C (113 °F)
Min Ambient Temperature (Ta Min)	-20 °C (-4 °F)
Total Heat Dissipation (Calculated +/- 10%)	172.8 BTU/H 590 W @ 240 V 179.3 BTU/H 612 W @ 120 V
Minimum distance to illuminated surface	2 m (6.56 ft)
Minimum distance to combustible surface	3 m (9.84 ft)
Thermal Protection system	Yes
Cooling modes	See Acoustics
Cooling System	<ul style="list-style-type: none"> <li>Advanced Liquid Cooling.</li> <li>IP68 Self-adjusting variable speed fans for quiet operation.</li> </ul>

## TECHNICAL SPECIFICATIONS

### ACOUSTICS STATIC

Fan Mode	dBA <sup>1</sup>	NC <sup>2</sup>
Auto	36.3 dBA	26
Stage	38.1 dBA	28
Silence/Studio	27.7 dBA	NA
Super Silence	27.4 dBA	NA

### DYNAMIC

Mode	dBA <sup>1</sup>	NC <sup>2</sup>
Auto	43.7 dBA	34
Stage	44 dBA	33
Silence/Studio	43.4 dBA	34
Super Silence	44.1dBA	35

1. Measured @ 1m Static, 31dBA ambient

2. Noise Criterion

[https://www.engineeringtoolbox.com/nc-noise-criterion-d\\_517.html](https://www.engineeringtoolbox.com/nc-noise-criterion-d_517.html)

### ENVIRONMENTAL

IP Rating	IP65 / IP66
Salt Spray Testing	Pending
Estimated embodied carbon including: <ul style="list-style-type: none"> <li>A1 - Raw materials of fixture and packaging</li> <li>A3 - Product manufacturing</li> </ul>	285.3 kg CO <sub>2</sub> e
Recycling options	Packaging fully recycled and widely recyclable
SIP Optional	Yes

#### Our Environmental Commitment

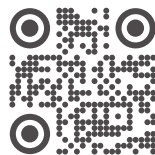

### WARRANTY

Fixture	2 years
LED Engine	5 years

From date of invoice

### INSTALLATION

Orientation	Any
Mounting attachments	<ul style="list-style-type: none"> <li>Fastening bracket system: two Omega ¼ turn brackets designed for use with standard clamps.</li> <li>Mounting points: four ¼ turn locking fittings allowing installation of Omega brackets on luminaire.</li> <li>Safety cable attachment point.</li> </ul>
Installation version	TBC

### CONSTRUCTION

Colour	Carbon Black Standard Custom colours on request
Housing	ABS PC (VO class)
Materials	<ul style="list-style-type: none"> <li>Moving-head skeleton made of aluminium and steel metal plates.</li> <li>Base in die-cast aluminium.</li> <li>Heatsinks in aluminium and copper.</li> <li>Moulded covers in self-extinguishing fire-retardant ABS PC (VO class).</li> <li>Four-side handles for transportation.</li> <li>Four heavy-duty feet for better stability.</li> </ul>

### INCLUDED ITEMS

Manual	1
OMEGA brackets with quarter-turn locks	2
Cables	<ul style="list-style-type: none"> <li>IP65: 1.5 m powerCON True1 TOP Tails Bared End</li> <li>IP66: Tails Bared End</li> </ul>
Other accessories	N/A

## TECHNICAL SPECIFICATIONS

PHYSICAL	
<b>Fixture</b>	
Length	360 mm (14.2 in)
Height	675.5 mm (26.6 in)
Depth	315 mm (12.4 in)
Weight	30.8 kg (67.9 lb)
<b>IP65</b>	
Length	360 mm (14.2 in)
Height	675.5 mm (26.6 in)
Depth	315 mm (12.4 in)
Weight	30.8 kg (67.9 lb)
<b>IP66</b>	
Length	360 mm (14.2 in)
Height	675.5 mm (26.6 in)
Depth	315 mm (12.4 in)
Weight	30.8 kg (67.9 lb)
<b>Shipping Dimensions</b>	
Length	485 mm (19 in)
Height	560 mm (22 in)
Depth	565 mm (22.2 in)
Weight	43.8 kg (94.8 lb)
<b>In SIP Dimensions</b>	
Length	485 mm (19 in)
Height	560 mm (22 in)
Depth	565 mm (22.2 in)
Weight (excl fixture)	12 kg (26.4 lb)

## SUPPORTING DOCUMENTS

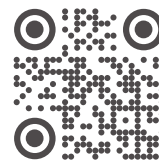
[Manual](#)
[GDTF Profile](#)
[GMA Profile](#)
[IES File](#)
[DMX Chart](#)
[Software](#)
[Warranty](#)

## COMPLIANCE

**EU (EMC & LVD)**

- EMC Directive 2014/30/EU
- LVD Directive 2014/35/EU

**US (Safety & EMC)**

- UL 1573
- FCC Part 15, Subpart B: 2018

**ROHS Compliant**

Yes

**Declarations**

Scan the QR code above

## ORDERING DETAILS

**Rivale Profile S**

012321

## ACCESSORIES

**IP Test Kit**

048250

**Lynx Control**

045130

**Omega Bracket**

GP50501990353

TECHNICAL SPECIFICATIONS

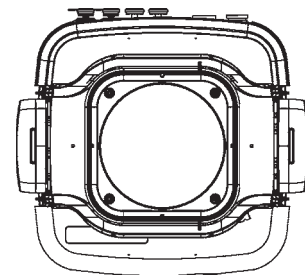
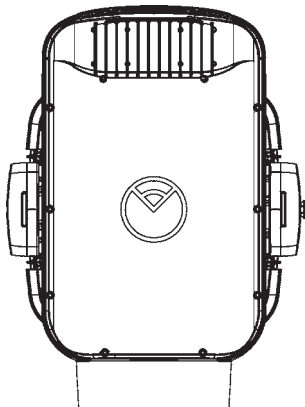
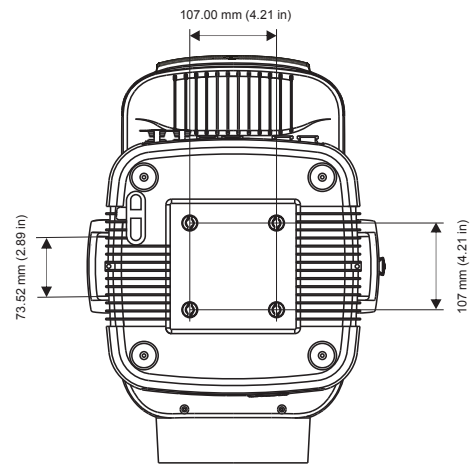
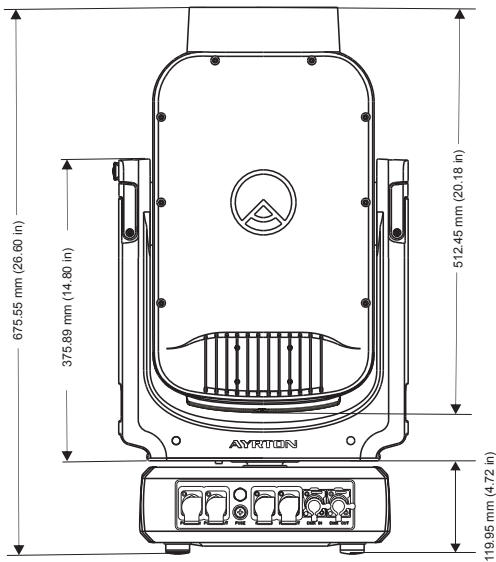
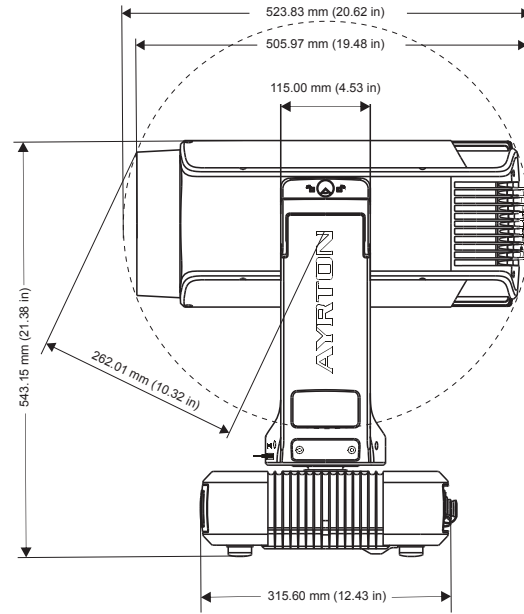
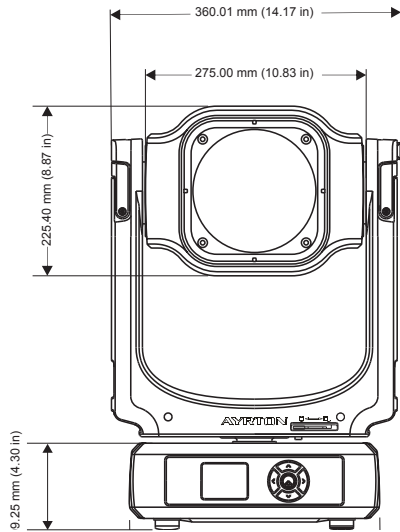

TECHNICAL SPECIFICATIONS

> Dimension/Tolerance/Requirement:

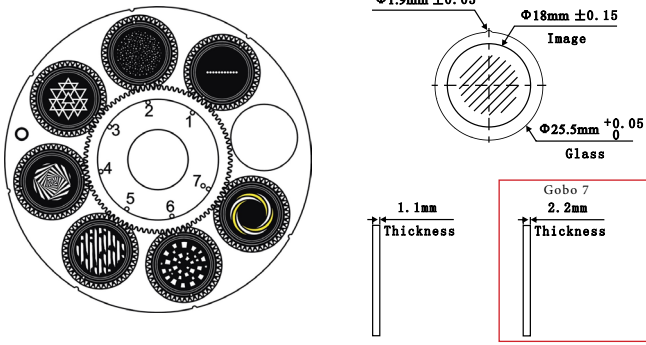

> Temperature Tolerance: 500°C

> Dimension/Tolerance/Requirement:

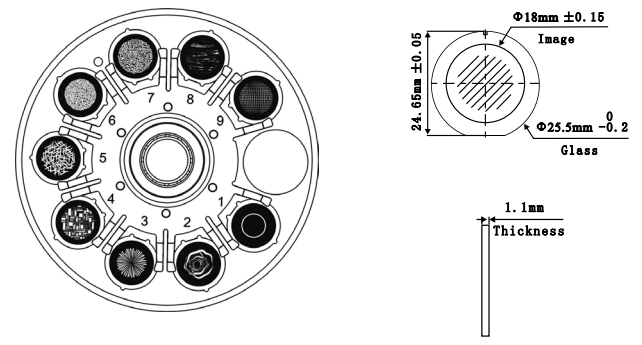

> Temperature Tolerance: 500°C

GOBO WHEEL 1

Rotating Gobo

1	130	Dot Line 11	GP60303012490
2	075	Star field	GP60303012515
3	018	Nested Triangle	GP60303012492
4	039	Infinite Stairs	GP60303012496
5	278	Bread Stix	GP60303012514
6	070	Circle of Square	GP60303012516
7	112Y	Nested Rings Yellow	GP60303012494

This side facing LED module

GOBO WHEEL 2

Static Gobo

1	410	Conical Tunnel Effect	GP60303012346
2	049	Smoke Rings	GP60303012455
3	047	Fireworks	GP60303012456
4	066	Abstract Square	GP60303012458
5	081	Iron Filings	GP60303012459
6	041	Lost in the Brain	GP60303012457
4	101	Deep Forest	GP60303012460
8	105	Tree Bark	GP60303012461
9	190	Mirror Ball	GP60303012462

This side facing LED module

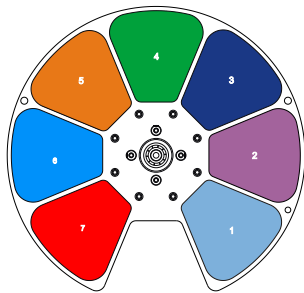

COLOUR WHEEL

1	CTB 1/4	GP60305032892
2	Magenta	GP60305032893
3	Congo Blue	GP60305032894
4	Green	GP60305032895
5	Orange	GP60305032896
6	Blue	GP60305032897
7	Red	GP60305032898

This side facing LED module

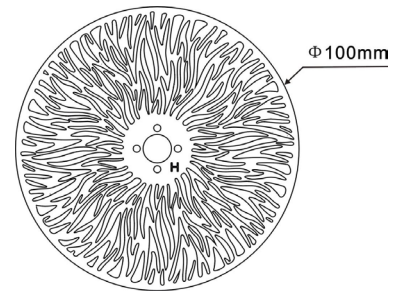

ANIMATION WHEEL

-	-	GPD0100077
---	---	------------

AUTO MODE: PHOTOMETRIC DETAIL

MIN ZOOM

BEAM OPENING

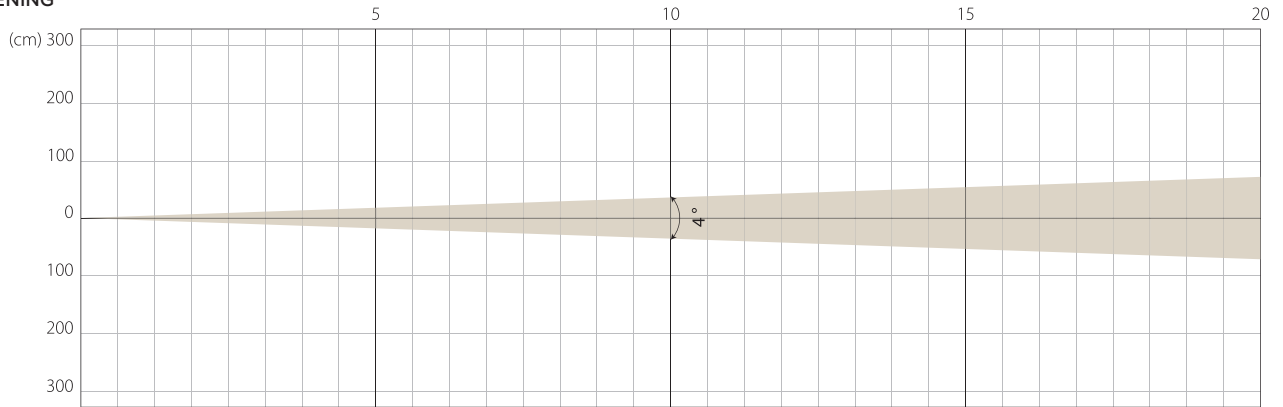

INTENSITY

Distance (m)	5		10		15		20	
unit	Lux	Diameter	Lux	Diameter	Lux	Diameter	Lux	Diameter
White	110063	0,35	27516	0,7	12229	1,05	6879	1,4

MIDDLE ZOOM

BEAM OPENING

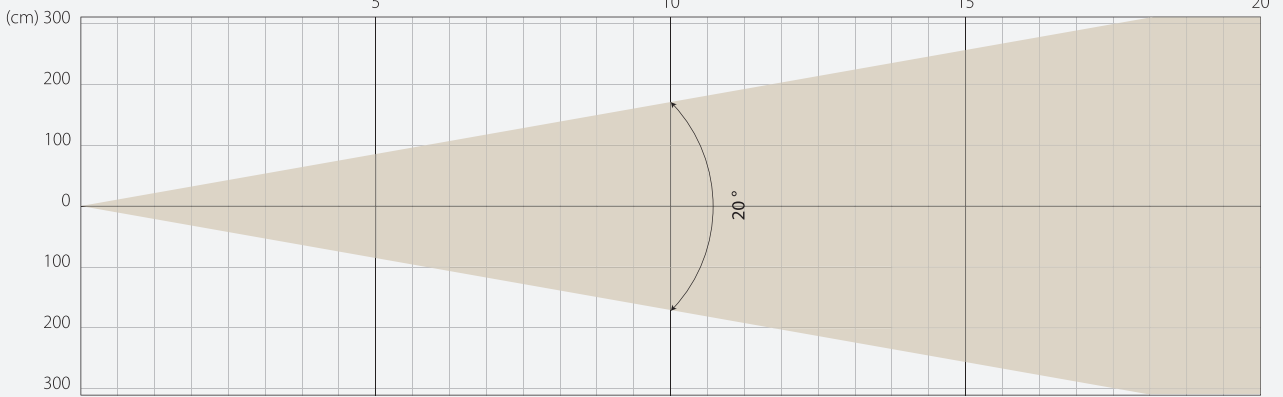

INTENSITY

Distance (m)	5		10		15		20	
unit	Lux	Diameter	Lux	Diameter	Lux	Diameter	Lux	Diameter
White	15199	1,76	3800	3,53	1689	5,29	950	7,05

MAX ZOOM

BEAM OPENING

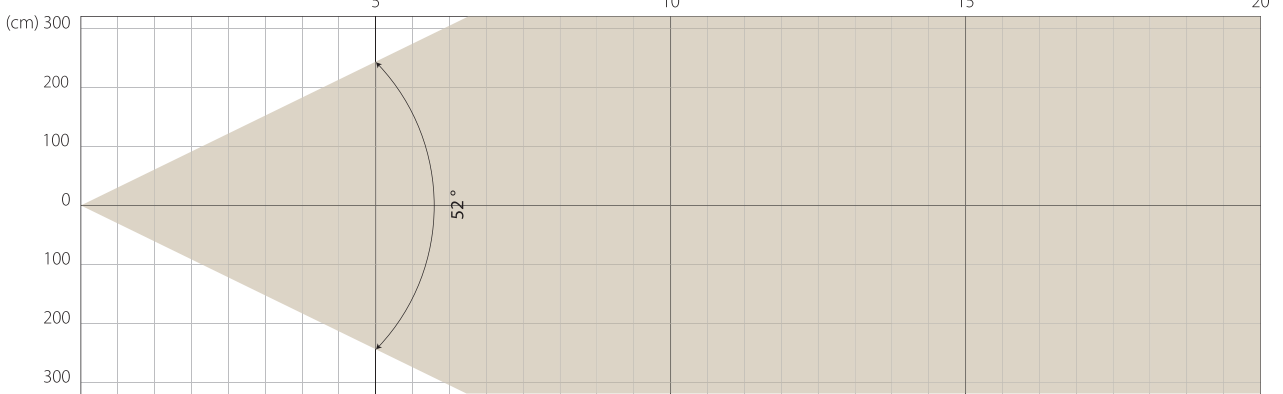

INTENSITY

Distance (m)	5		10		15		20	
unit	Lux	Diameter	Lux	Diameter	Lux	Diameter	Lux	Diameter
White	1715	4,88	429	9,75	191	14,63	107	19,51

STAGE MODE: PHOTOMETRIC DETAIL

MIN ZOOM

BEAM OPENING

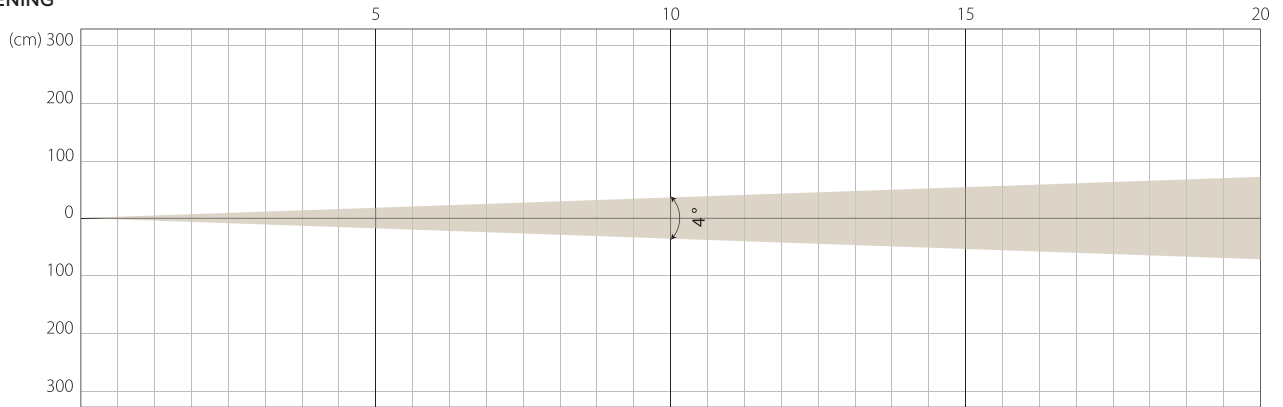

INTENSITY

Distance (m)	5		10		15		20	
unit	Lux	Diameter	Lux	Diameter	Lux	Diameter	Lux	Diameter
White	110499	0,35	27625	0,7	12278	1,05	6906	1,4

MIDDLE ZOOM

BEAM OPENING

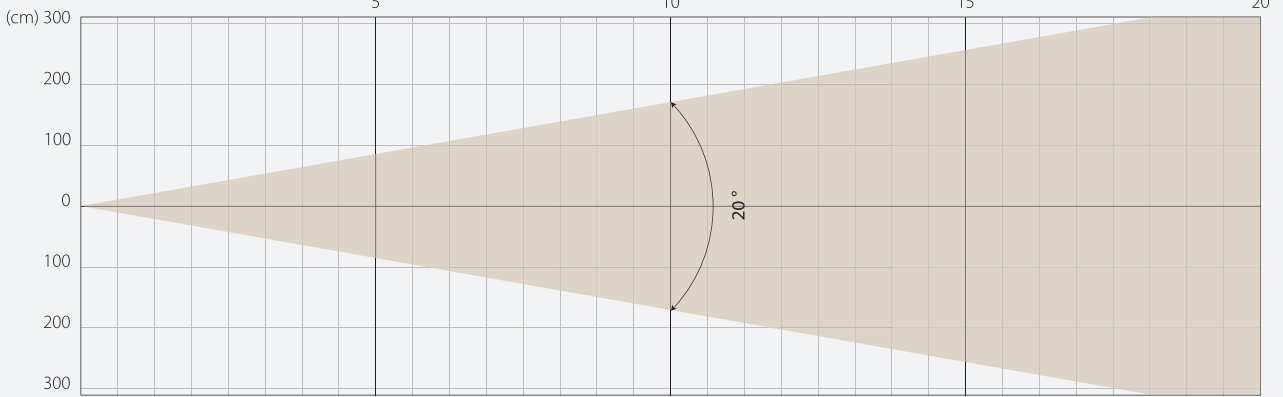

INTENSITY

Distance (m)	5		10		15		20	
unit	Lux	Diameter	Lux	Diameter	Lux	Diameter	Lux	Diameter
White	15409	1,76	3852	3,53	1712	5,29	963	7,05

MAX ZOOM

BEAM OPENING

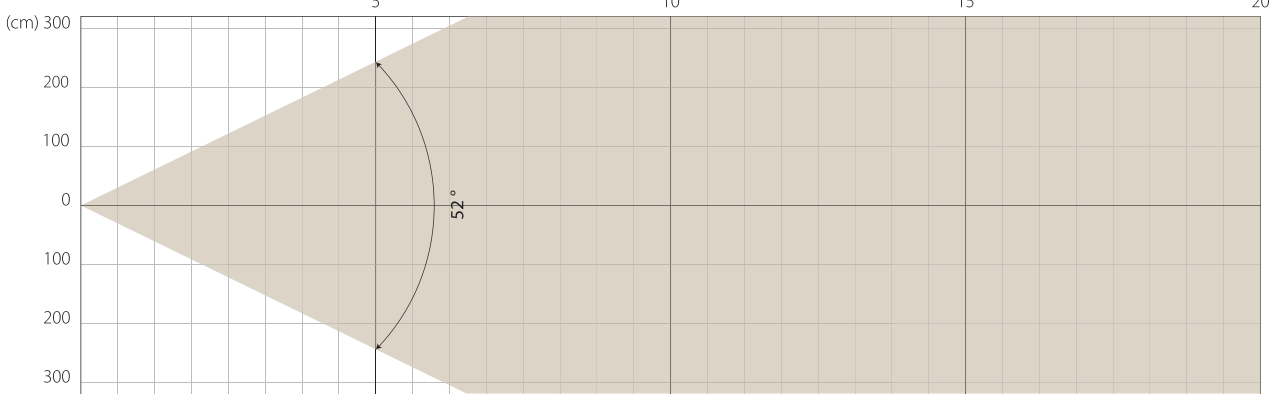

INTENSITY

Distance (m)	5		10		15		20	
unit	Lux	Diameter	Lux	Diameter	Lux	Diameter	Lux	Diameter
White	1734	4,88	434	9,75	193	14,63	108	19,51

SILENCE MODE: PHOTOMETRIC DETAIL

MIN ZOOM

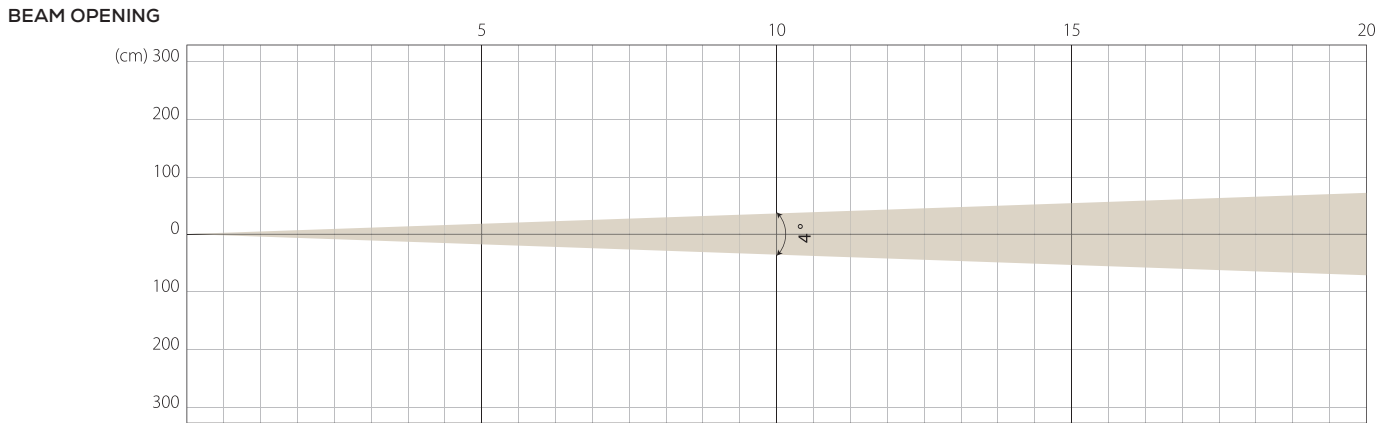

INTENSITY

Distance (m)	5		10		15		20	
	Lux	Diameter	Lux	Diameter	Lux	Diameter	Lux	Diameter
White	69586	0,35	17396	0,7	7732	1,05	4349	1,4

MIDDLE ZOOM

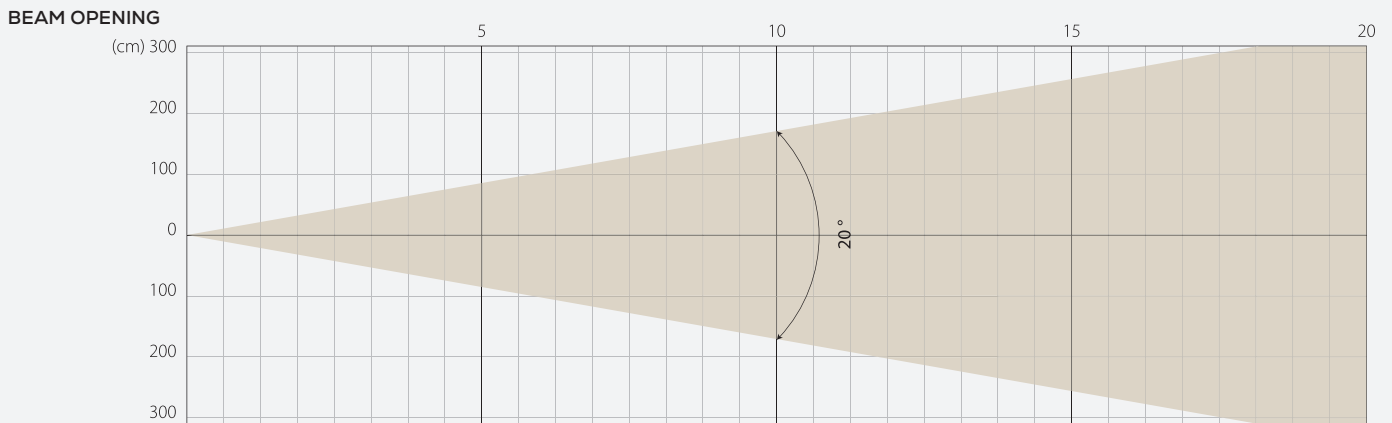

INTENSITY

Distance (m)	5		10		15		20	
	Lux	Diameter	Lux	Diameter	Lux	Diameter	Lux	Diameter
White	9526	1,76	2382	3,53	1058	5,29	595	7,05

MAX ZOOM

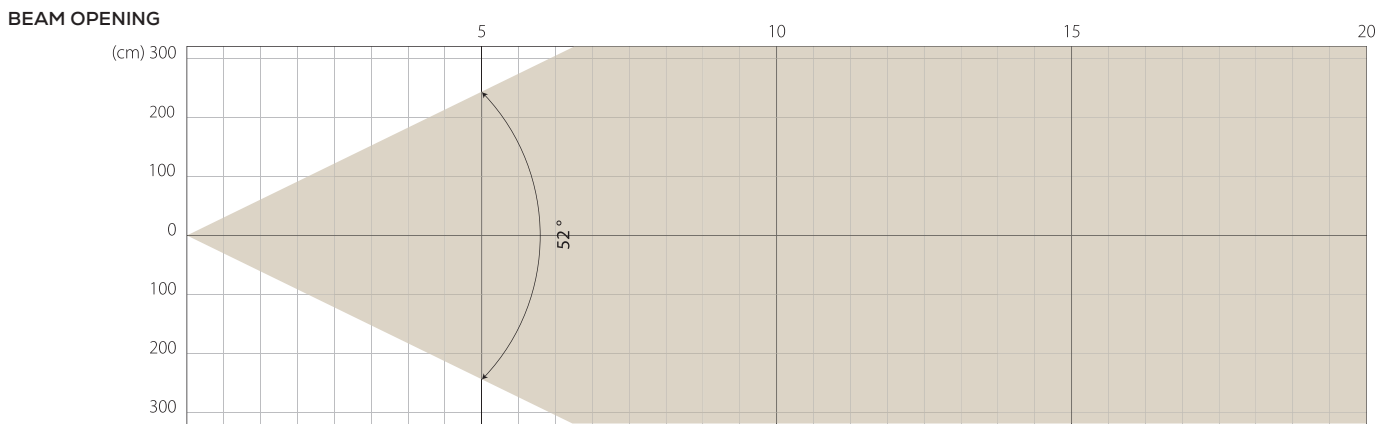

INTENSITY

Distance (m)	5		10		15		20	
	Lux	Diameter	Lux	Diameter	Lux	Diameter	Lux	Diameter
White	1051	4,88	263	9,75	117	14,63	66	19,51

**SUPER SILENCE MODE: PHOTOMETRIC DETAIL**

MIN ZOOM

BEAM OPENING

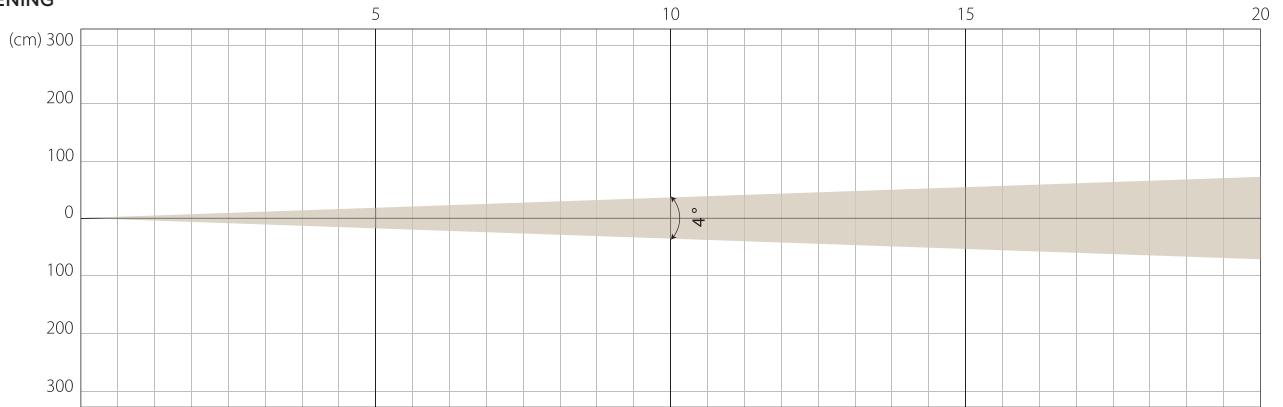

INTENSITY

Distance (m)	5		10		15		20	
unit	Lux	Diameter	Lux	Diameter	Lux	Diameter	Lux	Diameter
White	46651	0,35	11663	0,7	5183	1,05	2916	1,4

MIDDLE ZOOM

BEAM OPENING

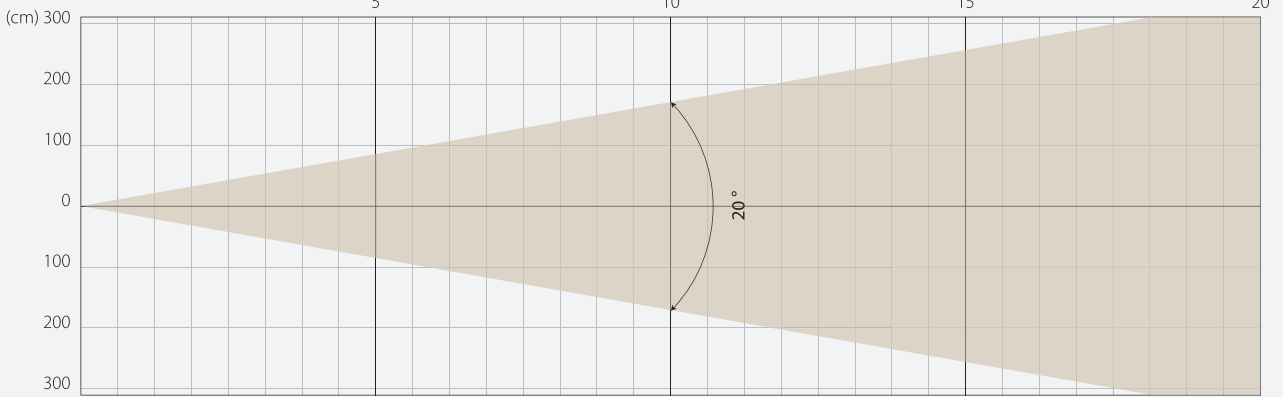

INTENSITY

Distance (m)	5		10		15		20	
unit	Lux	Diameter	Lux	Diameter	Lux	Diameter	Lux	Diameter
White	6536	1,76	1634	3,53	726	5,29	408	7,05

MAX ZOOM

BEAM OPENING

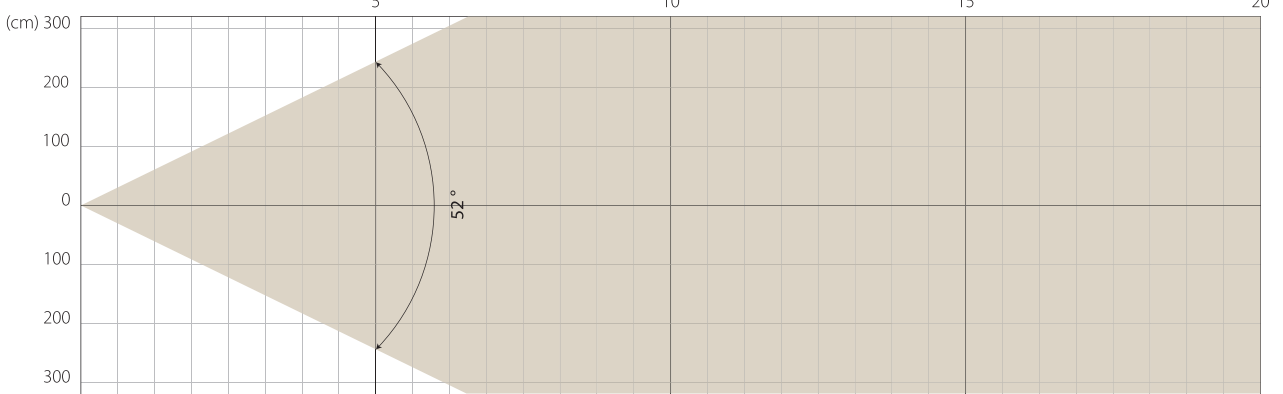

INTENSITY

Distance (m)	5		10		15		20	
unit	Lux	Diameter	Lux	Diameter	Lux	Diameter	Lux	Diameter
White	730	4,88	182	9,75	81	14,63	46	19,51

COLOUR PARAMETERS

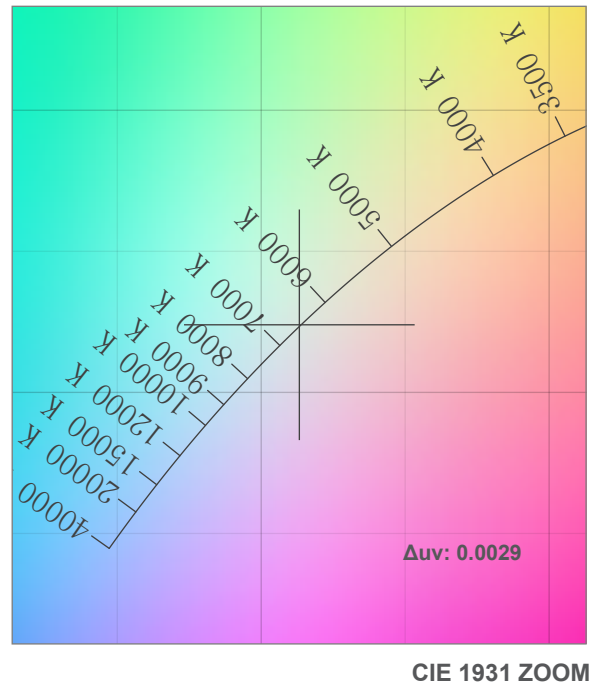
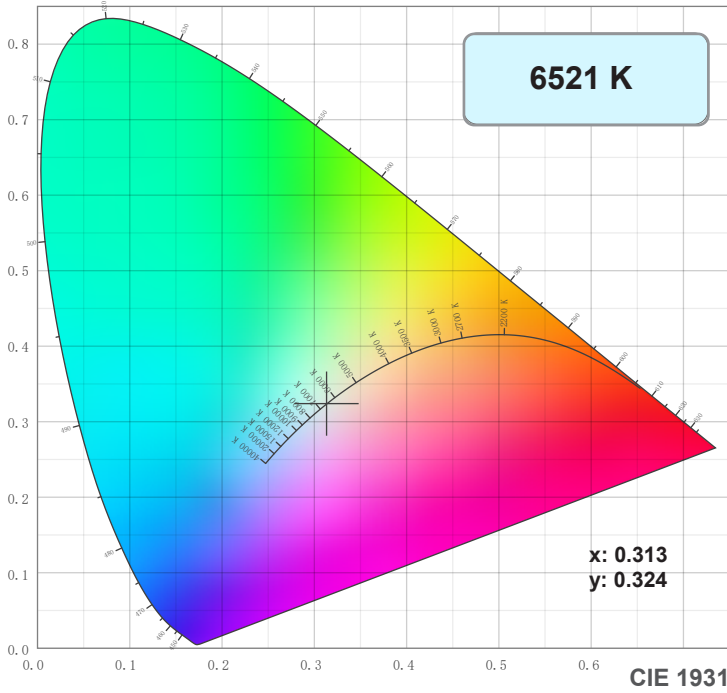

TM-30: 69.0

CRI: 69.2 (R1-R8)

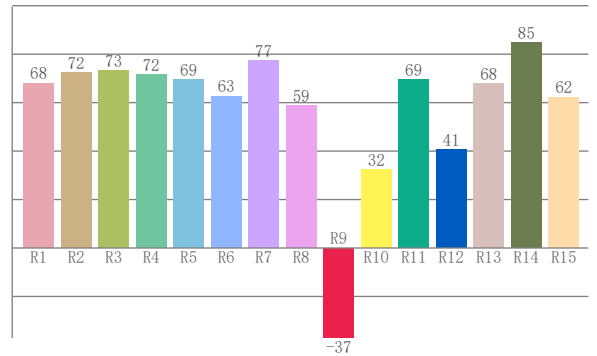
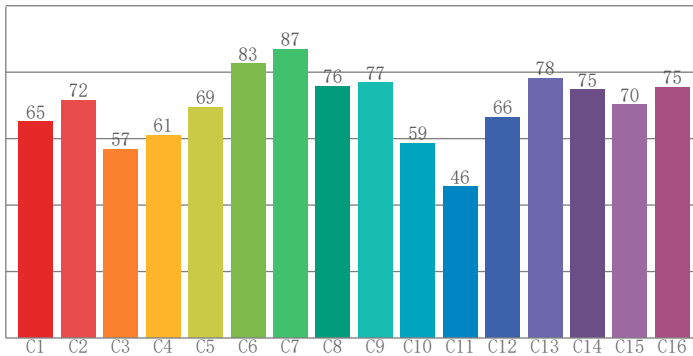

CRI R values, only R1-R8 are used to calculate final CRI value

R1	R2	R3	R4	R5	R6	R7	R8	R9	R10	R11	R12	R13	R14	R15
68.1	72.3	73.1	71.7	69.4	62.7	77.5	58.7	-37.1	32.3	69.4	40.6	67.8	84.6	62.3

TM30 C values, 16 binned values out of total of 99 C values

C1	C2	C3	C4	C5	C6	C7	C8	C9	C10	C11	C12	C13	C14	C15	C16
65.0	71.5	56.8	61.1	69.5	82.6	86.9	75.7	76.9	58.6	45.5	66.5	78.2	74.8	70.2	75.5

CQS Q values

Q1	Q2	Q3	Q4	Q5	Q6	Q7	Q8	Q9	Q10	Q11	Q12	Q13	Q14	Q15
79.0	90.5	58.1	51.4	64.6	69.8	75.1	85.5	86.1	66.4	59.6	61.7	65.7	54.0	64.7

CQS: 66.7

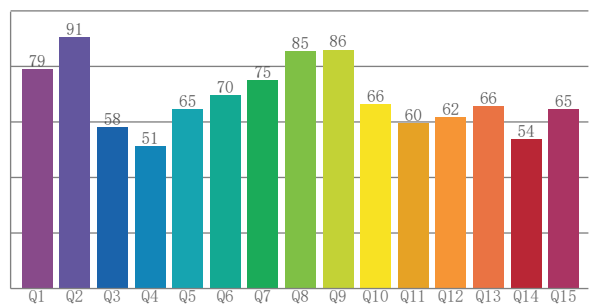

Color parameters

Color temperature	Color rendering index	Red component	Color fidelity	Color gamut	Color quality scale	Color coordinate cie 1931	Color coordinate cie 1931	Color coordinate	Color coordinate	Color deviation from black body
CCT	CRI	CRI R9	TM30 Rf	TM30 Rg	CQS	x	y	u	v	Δuv
6521 K	69.2	-37.1	69.0	93.6	66.7	0.313	0.324	0.200	0.310	0.0029

TM-30







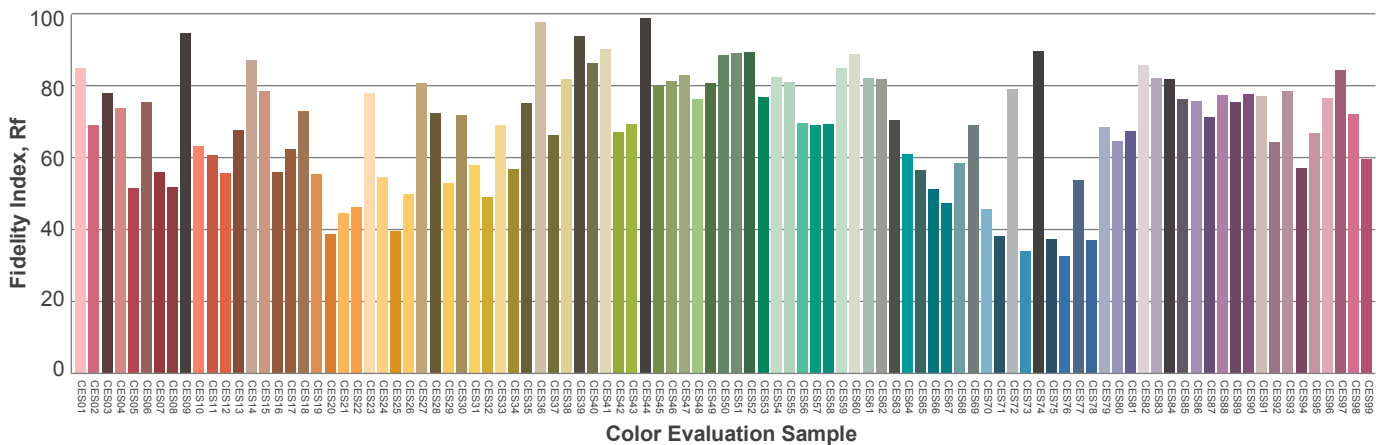
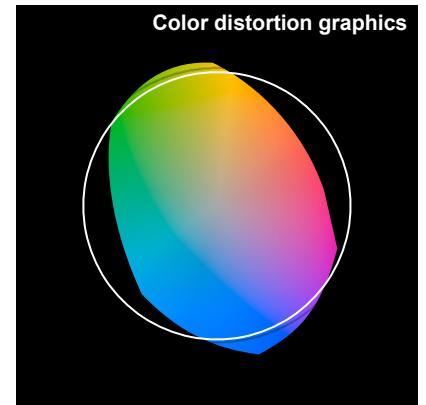
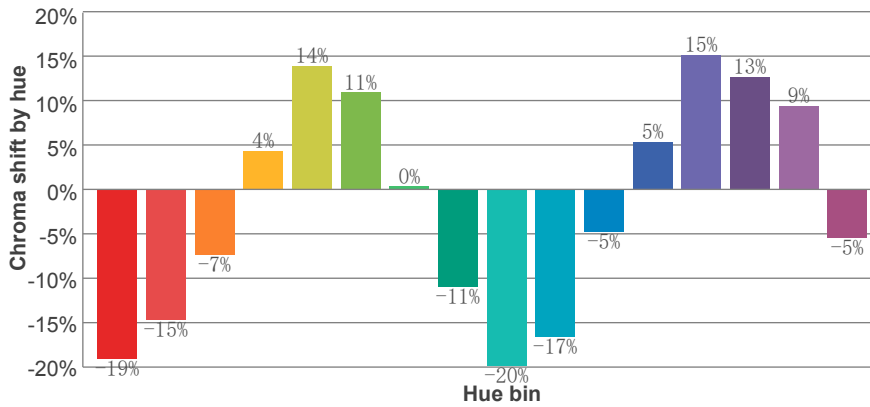
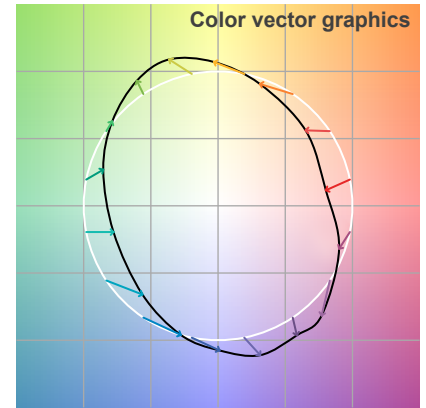
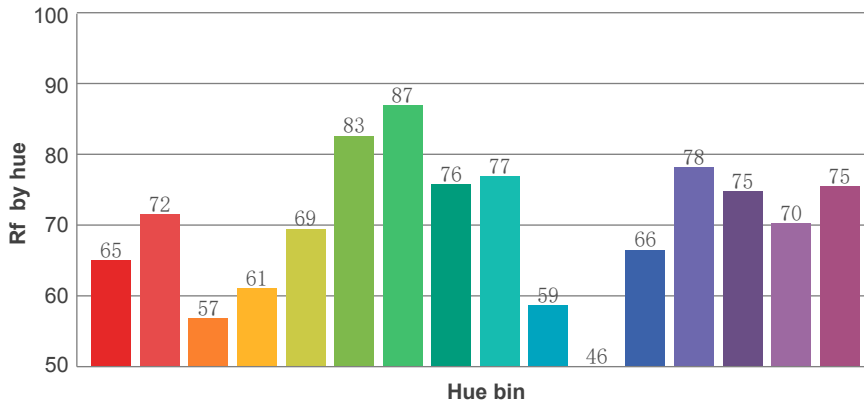
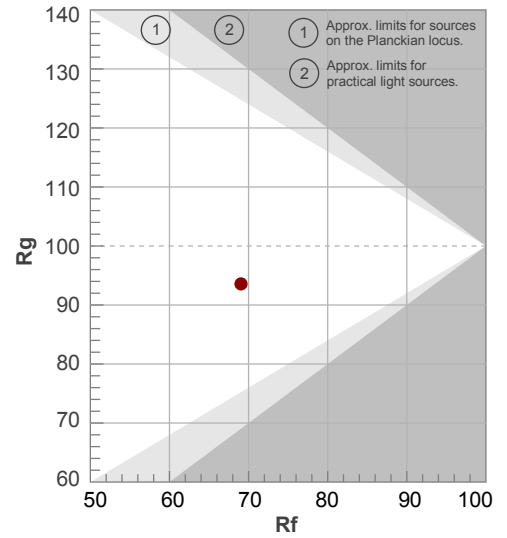



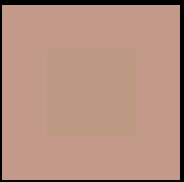

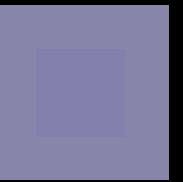
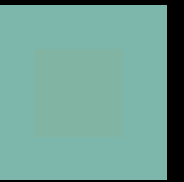
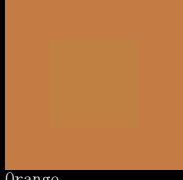

**Rf 69.0**  
Fidelity index Rf

**Rg 93.6**  
Gamut index Rg

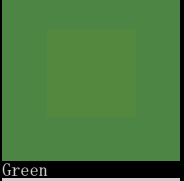
Hue Bin	R <sub>f</sub>	Shifts (%)	
		Chroma	Hue
1	65	-19%	-4%
2	72	-15%	10%
3	57	-7%	24%
4	61	4%	24%
5	69	14%	14%
6	83	11%	-1%
7	87	0%	-8%
8	76	-11%	-10%
9	77	-20%	4%
10	59	-17%	24%
11	46	-5%	30%
12	66	5%	22%
13	78	15%	9%
14	75	13%	-5%
15	70	9%	-25%
16	75	-5%	-14%

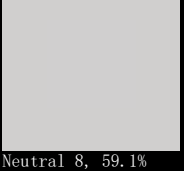
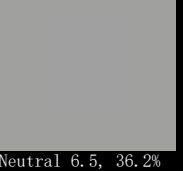
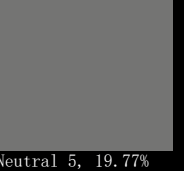
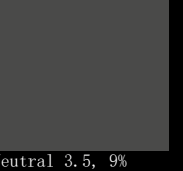
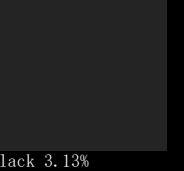

TLCI-47

					
Dark skin	Light skin	Blue sky	Foliage	Blue flower	Bluish green
					
Orange	Purplish blue	Moderate red	Purple	Yellow green	Orange yellow
					
Blue	Green	Red	Yellow	Magenta	Cyan
					
White 90.01%	Neutral 8, 59.1%	Neutral 6.5, 36.2%	Neutral 5, 19.77%	Neutral 3.5, 9%	Black 3.13%

**⚠️ DISCLAIMER**

Errors and omissions for all information given in this specification sheet are possible. All information is subject to change without prior notice.